

Amelie _Parete



Amelie è una collezione di lampade a batteria, portatili e ricaricabili, progettate dalla designer Sara Moroni, che comprende le tipologie da tavolo, terra, parete, a sospensione e con picchetto.

Le lampade da parete vengono fornite con un gancio e un tappo in silicone, che permettono di trasformarli in una sospensione.

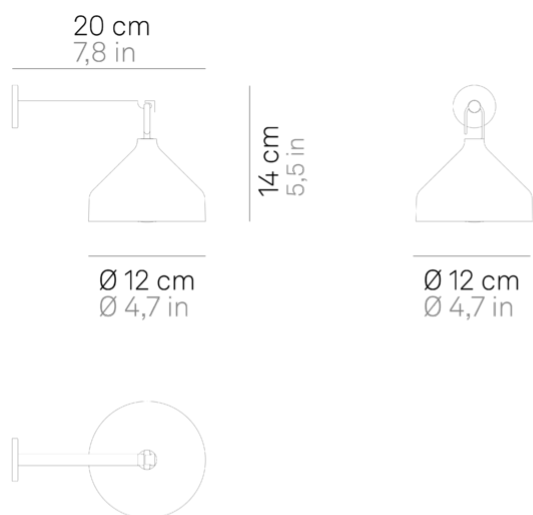

Un controllo "touch" presente nella parte superiore della testa permette l'accensione, la regolazione dell'intensità luminosa e la selezione della temperatura di colore della luce tra 2200 K, 2700 K e 3000 K.

Grazie a un alto indice di protezione, le lampade della collezione sono utilizzabili anche all'esterno. Sono dotate di base di ricarica a contatto. Caricabatterie non incluso.



LED dimmerabile IP65

LD1092

	Bianco	B3		Nero	D3
	Terracotta	T3		Verde foglia	V3



DESIGN IN ITALY BY ZAFFERANO SRL, MADE IN PRC

Zafferano SRL - Viale dell'Industria, 26 31055 Quinto di Treviso - Italy www.zafferanoitalia.com

Amelie _Parete

Specifiche illuminotecniche

sorgente	LED
tipologia	SMD
potenza totale	3.0 W
potenza scheda LED	3.0 W
temperatura colore	2200 - 2700 - 3000 K
lumen lampada	95 - 116 - 130 lm
lumen LED	253 - 300 - 308 lm
fascio luminoso	110°
CRI	> 80
classe energetica sorgente luminosa	G
dimmer	TOUCH DIMMER
sensore di presenza	NO

Specifiche elettriche

classe	3
tensione di alimentazione	5Vdc max.1A
batteria	batteria a pacchetto li-ion 2 celle mod.18650 3.7v - 4400 ma/h
autonomia	10 h.
tempo di ricarica	6 h.

ACCESSORI

LD0340RA



6 cm • 13.5 cm • 4.5 cm • 3.0 W
• IP20 • 100-240V • 50/60 Hz

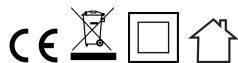

■ Nero

LD0490UA

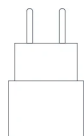

2.5 cm • 4 cm • 8 cm • IP20
• 100-240V • 50/60 Hz

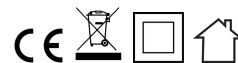

■ Bianco

LD0870RP



29 cm • 47 cm • 4 cm • 3.0 W
• IP20 • 100-240V • 50/60 Hz

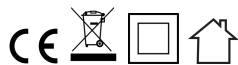

■ Nero