

Swap 230V _parete

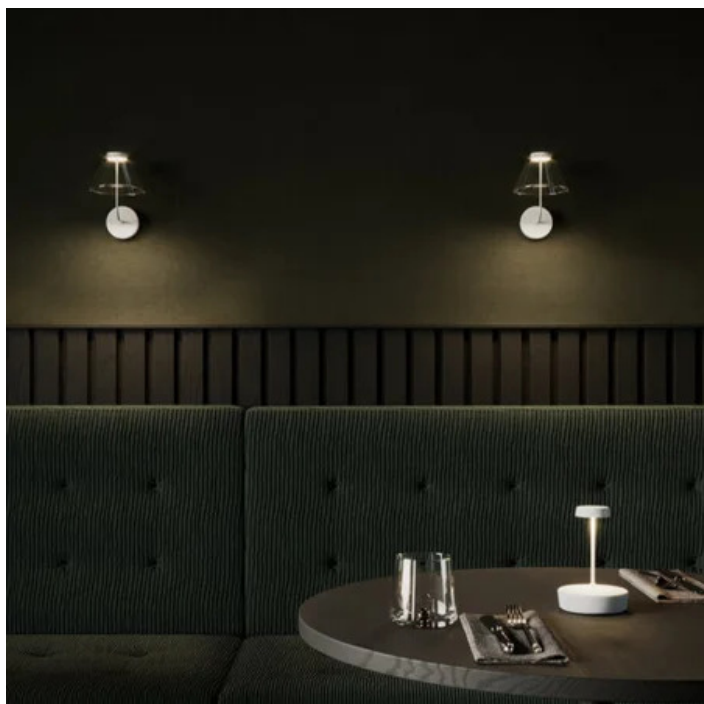

Lampade da parete e da parete-soffitto con struttura in pressofusione di alluminio verniciato bianco, corten o nero opaco e diffusore in policarbonato trasparente. I modelli da parete possono essere personalizzati con una gamma di paralumi in vetro o con un "fazzoletto" in tessuto, che si fissano alla testa della lampada tramite un magnete.

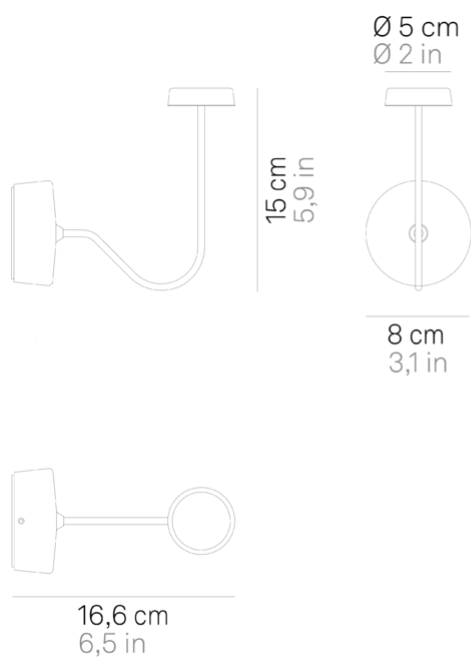

LED non sostituibile

non dimmerabile

IP20

LD1015

	Bianco	B3		Nero	N3
	Corten	R3			

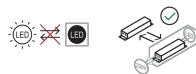

DESIGN IN ITALY BY ZAFFERANO SRL, China

Zafferano SRL - Viale dell'Industria, 26 31055 Quinto di Treviso
- Italy www.zafferanoitalia.com

Swap 230V _parete

Specifiche illuminotecniche

sorgente	LED non sostituibile
tipologia	SMD
potenza totale	40 W
potenza scheda LED	30 W
temperatura colore	2700 K
lumen lampada	300 lm
lumen LED	390 lm
fascio luminoso	118°
CRI	> 90
classe energetica sorgente luminosa	E

Specifiche elettriche

classe	1
tensione di rete	220-240V
frequenza	50/60 Hz
input	220-240V
output	500 mA 25-8V
batteria	

ACCESSORI
