

# Push-Up \_Table

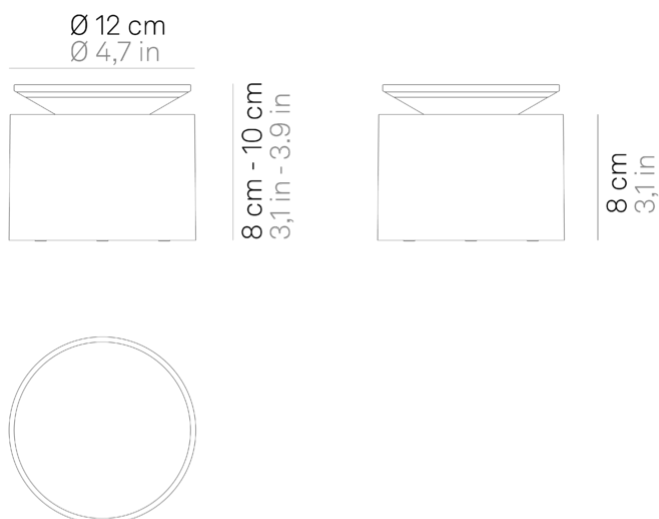





Push-up is a rechargeable battery-powered cordless table lamp. Pushing the lid down, lifts the diffuser up and turns the light on; pushing the lid back down, closes the lamp while turning the light off. A "touch" control hidden under the base allows switching on/off, dimming, and selecting the color temperature of the light (2200 K, 2700 K or 3000 K). It is suitable for both indoor and outdoor use. An electronic control system monitors the remaining autonomy and ensures a constant luminous flux until the battery runs out. Recharging is therefore optimized and always properly done. The lamp comes with a contact charging base; the battery charger is not included.



LED dimmable IP54

## LD1050

	White	<b>B3</b>		<b>R3</b>
	Dark gray	<b>N3</b>		<b>S3</b>



DESIGN IN ITALY BY ZAFFERANO SRL, MADE IN PRC

Zafferano SRL - Viale dell'Industria, 26 31055 Quinto di Treviso - Italy [www.zafferanoitalia.com](http://www.zafferanoitalia.com)

# Push-Up \_Table

## Lighting specifications

source	LED
type	SMD
total power	2.2 W
power LED	2.2 W
color temperature	2200 - 2700 - 3000 K
lumen lamp	105 - 127 - 134 lm
lumen LED	207 - 235 - 248 lm
beam angle	45°
CRI	> 80
class	F
dimmer	TOUCH DIMMER
motion sensor	NO

## Electrical specifications

classe	3
supply voltage	5Vdc max.1A
battery	1 cell li-ion battery pack mod. 18650 3,7v - 2200 ma/h
battery life	11/12 H.
charging time	5/6 H.

## ACCESSORIES

### LD0340RA



6 cm • 13.5 cm • 4.5 cm • 2.2 W  
• IP20 • 100-240V • 50/60 Hz



■ Black

### LD0350RP

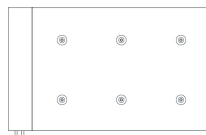

33 cm • 51 cm • 5.8 cm • 2.2 W  
• IP20 • 100-240V • 50/60 Hz

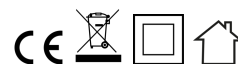

■ Black

### LD0490UA

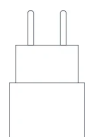

2.5 cm • 4 cm • 8 cm • IP20  
• 100-240V • 50/60 Hz

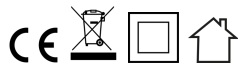

■ White

### LD1050RB



Ø 10 cm • 1.1 cm • IP20  
• 5Vdc max.1A • 50/60 Hz



■ Black